

## HIGHLIGHTS OF PRESCRIBING INFORMATION

These highlights do not include all the information needed to use MIRENA safely and effectively. See full prescribing information for MIRENA.

MIRENA (levonorgestrel-releasing intrauterine system)

Initial U.S. Approval: 2000

### INDICATIONS AND USAGE

Mirena is a progestin-containing intrauterine system (IUS) indicated for:

- Prevention of pregnancy for up to 8 years (1.1)
- Treatment of heavy menstrual bleeding for women who choose to use intrauterine contraception as their method of contraception for up to 5 years. (1.2)

### DOSAGE AND ADMINISTRATION

- Release rate of levonorgestrel (LNG) is 21 mcg/day after 24 days; this rate is reduced to about 11 mcg/day after 5 years and 7 mcg/day after 8 years. (2.1)
- To be inserted by a trained healthcare provider using strict aseptic technique. Follow insertion instructions exactly as described. (2.2)
- Patient should be re-examined and evaluated 4 to 6 weeks after insertion; then, yearly or more often if clinically indicated. (2.3)

### DOSAGE FORMS AND STRENGTHS

- One sterile intrauterine system consisting of a T-shaped polyethylene frame with a steroid reservoir containing 52 mg levonorgestrel packaged within a sterile inserter (3)

### CONTRAINDICATIONS

- Pregnancy or suspicion of pregnancy. Cannot be used for post-coital contraception (emergency contraception) (4).
- Congenital or acquired uterine anomaly if it distorts the uterine cavity (4)
- Acute pelvic inflammatory disease (PID) or a history of PID unless there has been a subsequent intrauterine pregnancy (4)

- Postpartum endometritis or infected abortion in the past 3 months (4)
- Known or suspected uterine or cervical malignancy (4)
- Known or suspected breast cancer or other progestin-sensitive cancer (4)
- Uterine bleeding of unknown etiology (4)
- Untreated acute cervicitis or vaginitis or other lower genital tract infections (4)
- Acute liver disease or liver tumor (benign or malignant) (4)
- Increased susceptibility to pelvic infection (4)
- A previous intrauterine device (IUD) that has not been removed (4)
- Hypersensitivity to any component of Mirena (4)

### WARNINGS AND PRECAUTIONS

- Remove Mirena if pregnancy occurs with Mirena in place. If pregnancy occurs, there is increased risk of ectopic pregnancy including loss of fertility, pregnancy loss, septic abortion (including septicemia, shock and death), and premature labor and delivery. (5.1, 5.2)
- Group A streptococcal infection has been reported following insertion of LNG IUS; strict aseptic technique is essential during insertion. (5.3)
- Before using Mirena, consider the risks of PID. (5.4)
- Uterine perforation may occur and may reduce contraceptive effectiveness or require surgery. Risk is increased if inserted in lactating women and may be increased if inserted in women with fixed retroverted uteri or postpartum. (5.5)
- Partial or complete expulsion may occur, which can be unnoticed, leading to loss of contraceptive efficacy. (5.6)
- Evaluate persistent enlarged ovarian follicles or ovarian cysts. (5.7)
- Bleeding patterns become altered, may remain irregular and amenorrhea may ensue. (5.8)

### ADVERSE REACTIONS

The most common adverse reactions ( $\geq 10\%$  users) are alterations of menstrual bleeding patterns, abdominal/pelvic pain, amenorrhea, headache/migraine, genital discharge, and vulvovaginitis. (6.1)

To report SUSPECTED ADVERSE REACTIONS, contact Bayer HealthCare Pharmaceuticals Inc. at 1-888-842-2937 or FDA at 1-800-FDA-1088 or [www.fda.gov/medwatch](http://www.fda.gov/medwatch).

See 17 for PATIENT COUNSELING INFORMATION and FDA-approved patient labeling.

Revised: 7/2024

## FULL PRESCRIBING INFORMATION: CONTENTS\*

### 1 INDICATIONS AND USAGE

- 1.1 Contraception
- 1.2 Heavy Menstrual Bleeding

### 2 DOSAGE AND ADMINISTRATION

- 2.1 Dosing Over Time
- 2.2 Insertion Instructions
- 2.3 Patient Follow-up
- 2.4 Removal of Mirena
- 2.5 Continuation of Contraception after Removal

### 3 DOSAGE FORMS AND STRENGTHS

### 4 CONTRAINDICATIONS

### 5 WARNINGS AND PRECAUTIONS

- 5.1 Risk of Ectopic Pregnancy
- 5.2 Risks with Intrauterine Pregnancy
- 5.3 Sepsis
- 5.4 Pelvic Infection
- 5.5 Perforation
- 5.6 Expulsion
- 5.7 Ovarian Cysts
- 5.8 Bleeding Pattern Alterations
- 5.9 Breast Cancer
- 5.10 Clinical Considerations for Use and Removal

### 6 ADVERSE REACTIONS

- 6.1 Clinical Trials Experience
- 6.2 Postmarketing Experience

### 7 DRUG INTERACTIONS

### 8 USE IN SPECIFIC POPULATIONS

- 8.1 Pregnancy
- 8.2 Lactation
- 8.3 Females and Males of Reproductive Potential
- 8.4 Pediatric Use
- 8.5 Geriatric Use

### 11 DESCRIPTION

- 11.1 Mirena
- 11.2 Inserter

### 12 CLINICAL PHARMACOLOGY

- 12.1 Mechanism of Action
- 12.2 Pharmacodynamics
- 12.3 Pharmacokinetics

### 13 NONCLINICAL TOXICOLOGY

- 13.1 Carcinogenesis, Mutagenesis, Impairment of Fertility

### 14 CLINICAL STUDIES

- 14.1 Clinical Trials on Contraception
- 14.2 Clinical Trial on Heavy Menstrual Bleeding

### 15 REFERENCES

### 16 HOW SUPPLIED/STORAGE AND HANDLING

### 17 PATIENT COUNSELING INFORMATION

\*Sections or subsections omitted from the full prescribing information are not listed.

## FULL PRESCRIBING INFORMATION

### 1 INDICATIONS AND USAGE

#### 1.1 Contraception

Mirena is indicated for prevention of pregnancy for up to 8 years; replace after the end of the eighth year.

#### 1.2 Heavy Menstrual Bleeding

Mirena is indicated for the treatment of heavy menstrual bleeding for up to 5 years in women who choose to use intrauterine contraception as their method of contraception; replace after the end of the fifth year if continued treatment of heavy menstrual bleeding is needed.

### 2 DOSAGE AND ADMINISTRATION

#### 2.1 Dosing Over Time

Mirena contains 52 mg of levonorgestrel (LNG) released in vivo, at a rate of approximately 21 mcg/day after 24 days. This rate decreases progressively to approximately 11 mcg/day after 5 years and 7 mcg/day after 8 years.

For contraception, remove Mirena by the end of the eighth year and replace at the time of removal with a new Mirena if continued use is desired.

For treatment of heavy menstrual bleeding, replace Mirena by the end of the fifth year if continued use is needed because data on use in this indication beyond 5 years are limited.

Mirena is supplied in a sterile package within an inserter that enables single-handed loading (see Figure 1). Do not open the package until required for insertion [see Description (11.2)]. Do not use if the seal of the sterile package is broken or appears compromised. Use strict aseptic techniques throughout the insertion procedure [see Warnings and Precautions (5.3)].

#### Mirena and Inserter

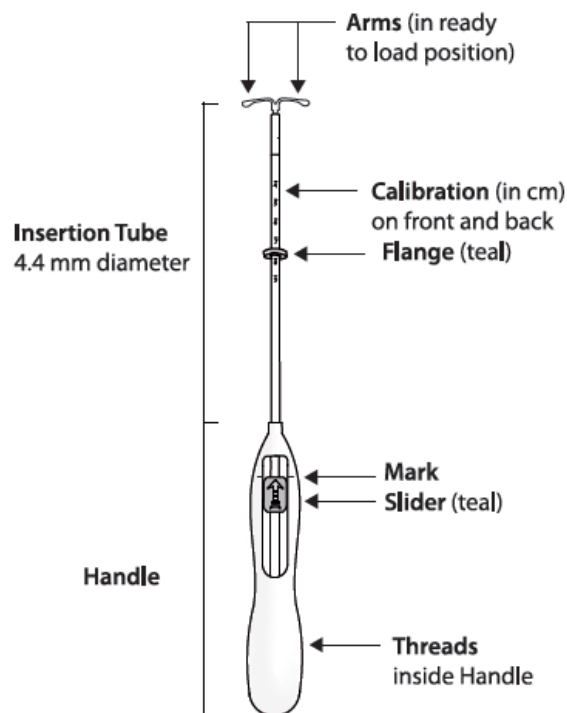

## 2.2 Insertion Instructions

- Obtain a complete medical and social history to determine conditions that might influence the selection of a levonorgestrel-releasing intrauterine system (LNG IUS) for contraception. If indicated, perform a physical examination, and appropriate tests for any forms of genital or other sexually transmitted infections. [See *Contraindications (4)* and *Warnings and Precautions (5.10)*.] Because irregular bleeding/spotting is common during the first months of Mirena use, exclude endometrial pathology (polyps or cancer) prior to the insertion of Mirena in women with persistent or uncharacteristic bleeding [see *Warnings and Precautions (5.8)*].
- Follow the insertion instructions exactly as described to ensure proper placement and avoid premature release of Mirena from the inserter. Once released, Mirena cannot be re-loaded.
- Check expiration date of Mirena prior to initiating insertion.
- Mirena should be inserted by a trained healthcare provider. Healthcare providers should become thoroughly familiar with the insertion instructions before attempting insertion of Mirena.
- Insertion may be associated with some pain and/or bleeding or vasovagal reactions (for example, syncope, bradycardia), or with seizure, especially in patients with a predisposition to these conditions. Consider administering analgesics prior to insertion.

### Timing of Insertion

**Table 1: When to Insert Mirena**

Starting Mirena in women not currently using hormonal or intrauterine contraception	<ul style="list-style-type: none"> <li>• Insert Mirena any time there is reasonable certainty that the woman is not pregnant. Consider the possibility of ovulation and conception prior to initiation of this product [see <i>Contraindications (4)</i>].</li> <li>• If Mirena is inserted during the first seven days of the menstrual cycle or immediately after a first trimester abortion, back-up contraception is not needed.</li> <li>• If Mirena is not inserted during the first seven days of the menstrual cycle, a barrier method of contraception should be used, or the patient should abstain from vaginal intercourse for seven days to prevent pregnancy.</li> </ul>
Switching to Mirena from an oral, transdermal, or vaginal hormonal contraceptive	<ul style="list-style-type: none"> <li>• Insert Mirena at any time, including during the hormone-free interval of the previous method.</li> <li>• If inserted during active use of the previous method, continue that method for 7 days after Mirena insertion or until the end of the current treatment cycle.</li> <li>• If the woman was using continuous hormonal contraception, discontinue that method seven days after Mirena insertion.</li> </ul>
Switching to Mirena from an injectable progestin contraceptive	<ul style="list-style-type: none"> <li>• Insert Mirena at any time; a non-hormonal back-up birth control (such as condoms or spermicide) should also be used for 7 days if Mirena is inserted more than 3 months (13 weeks) after the last injection.</li> </ul>
Switching to Mirena from a contraceptive implant or another IUS	<ul style="list-style-type: none"> <li>• Insert Mirena on the same day the implant or IUS is removed.</li> <li>• Insert Mirena at any time during the menstrual cycle.</li> </ul>
Inserting Mirena after first-trimester abortion or miscarriage	<ul style="list-style-type: none"> <li>• Insert Mirena immediately after a first-trimester abortion or miscarriage, unless it is a septic abortion [see <i>Contraindications (4)</i>].</li> </ul>
Inserting Mirena after childbirth or second-trimester abortion or miscarriage	
<ul style="list-style-type: none"> <li>• Immediate insertion after childbirth or second-trimester abortion or miscarriage</li> </ul>	<ul style="list-style-type: none"> <li>• Insert Mirena after removal of the placenta. Back-up contraception is not needed. [See <i>Contraindications (4)</i>, <i>Warnings and Precautions (5.5, 5.6)</i>, <i>Adverse Reactions (6.2)</i>].</li> </ul>

Interval insertion following complete involution of the uterus	<ul style="list-style-type: none"> <li>• Wait a minimum of 6 weeks or until the uterus is fully involuted before inserting Mirena [see <i>Warnings and Precautions (5.5, 5.6)</i>, <i>Adverse Reactions (6.2)</i>].</li> <li>• Insert Mirena any time there is reasonable certainty the woman is not pregnant.</li> <li>• If Mirena is not inserted during the first 7 days of the menstrual cycle, a back-up method of contraception should be used, or the woman should abstain from vaginal intercourse for 7 days to prevent pregnancy [see <i>Contraindications (4)</i>, <i>Warnings and Precautions (5.2)</i>].</li> </ul>
--	--

### *Tools for Insertion*

Note: The inserter provided with Mirena (see Figure 1) and the Insertion Procedure described in this section are not applicable for immediate insertion after childbirth or second-trimester abortion or miscarriage. For immediate insertion, remove Mirena from the inserter by first loading (see Figure 2) and then releasing (see Figure 7) Mirena from the inserter, and insert according to accepted practice.

### Preparation

- Gloves
- Speculum
- Sterile uterine sound
- Sterile tenaculum
- Antiseptic solution, applicator

### Procedure

- Sterile gloves
- Mirena with inserter in sealed package
- Instruments and anesthesia for paracervical block, if anticipated
- Consider having an unopened back-up Mirena available
- Sterile, sharp curved scissors

### *Preparation for insertion*

- Exclude pregnancy and confirm that there are no other contraindications to the use of Mirena.
- With the patient comfortably in lithotomy position, do a bimanual exam to establish the size, shape and position of the uterus.
- Gently insert a speculum to visualize the cervix.
- Thoroughly cleanse the cervix and vagina with a suitable antiseptic solution.
- Prepare to sound the uterine cavity. Grasp the upper lip of the cervix with a tenaculum forceps and gently apply traction to stabilize and align the cervical canal with the uterine cavity. Perform a paracervical block if needed. If the uterus is retroverted, it may be more appropriate to grasp the lower lip of the cervix. The tenaculum should remain in position and gentle traction on the cervix should be maintained throughout the insertion procedure.
- Gently insert a uterine sound to check the patency of the cervix, measure the depth of the uterine cavity in centimeters, confirm cavity direction, and detect the presence of any uterine anomaly. If you encounter difficulty or cervical stenosis, use dilatation, and not force, to overcome resistance. If cervical dilatation is required, consider using a paracervical block.
- The uterus should sound to a depth of 6 to 10 cm. Insertion of Mirena into a uterine cavity less than 6 cm by sounding may increase the incidence of expulsion, bleeding, pain, perforation, and possibly pregnancy.

### *Insertion Procedure*

Proceed with insertion only after completing the above steps and ascertaining that the patient is appropriate for Mirena. Ensure use of aseptic technique throughout the entire procedure.

### Step 1–Opening of the package

- Open the package ([Figure 1](#)). The contents of the package are sterile.

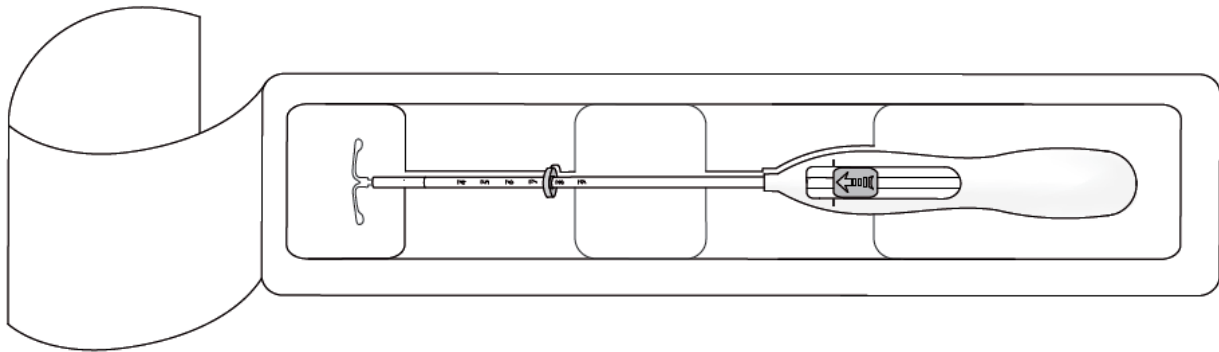
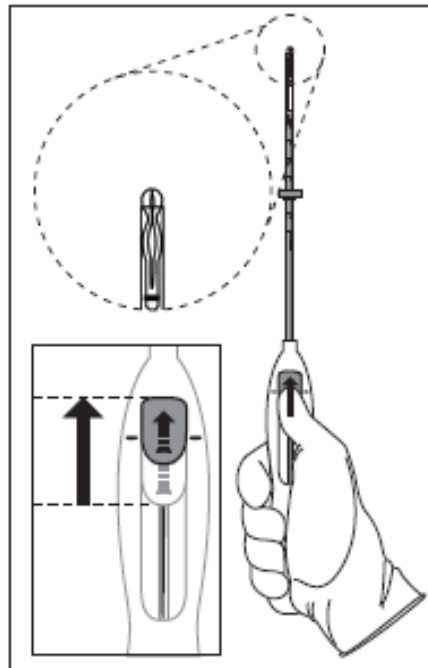

**Figure 1: Opening the Mirena Package**

- Using sterile gloves lift the handle of the sterile inserter and remove from the sterile package.

### Step 2–Load Mirena into the insertion tube

- Push the slider forward as far as possible in the direction of the arrow thereby moving the insertion tube over the Mirena T-body to load Mirena into the insertion tube ([Figure 2](#)). The tips of the arms will meet to form a rounded end that extends slightly beyond the insertion tube.

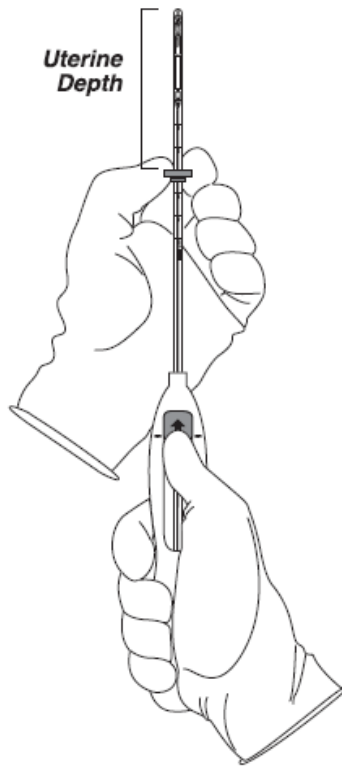

**Figure 2: Move slider all the way to the forward position to load Mirena**

- Maintain forward pressure with your thumb or forefinger on the slider. DO NOT move the slider downward at this time as this may prematurely release the threads of Mirena. Once the slider is moved below the mark, Mirena cannot be re-loaded.

### Step 3–Setting the Flange

- Holding the slider in this forward position, set the upper edge of the flange to correspond to the uterine depth (in centimeters) measured during sounding ([Figure 3](#)).



**Figure 3: Setting the flange**

Step 4–Mirena is now ready to be inserted

- Continue holding the slider in this forward position. Advance the inserter through the cervix until the flange is approximately 1.5–2 cm from the cervix and then pause ([Figure 4](#)).

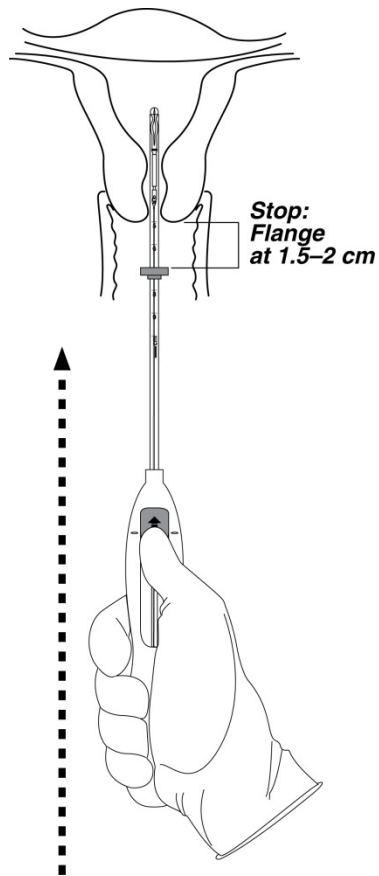
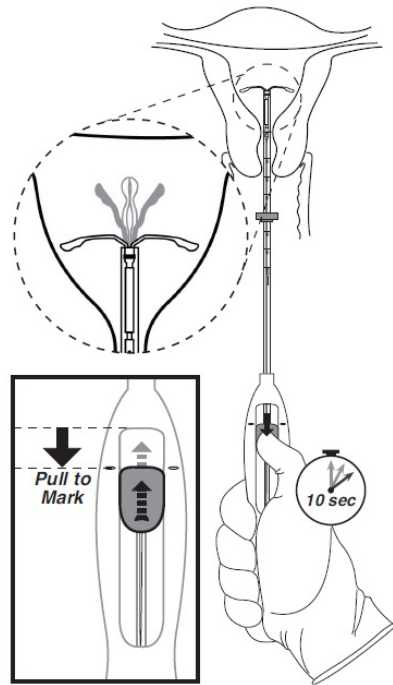

**Figure 4: Advancing insertion tube until flange is 1.5 to 2 cm from the cervix**

Do not force the inserter. If necessary, dilate the cervical canal.

Step 5—Open the arms

- While holding the inserter steady, move the slider down to the mark to release the arms of Mirena ([Figure 5](#)). Wait 10 seconds for the horizontal arms to open completely.

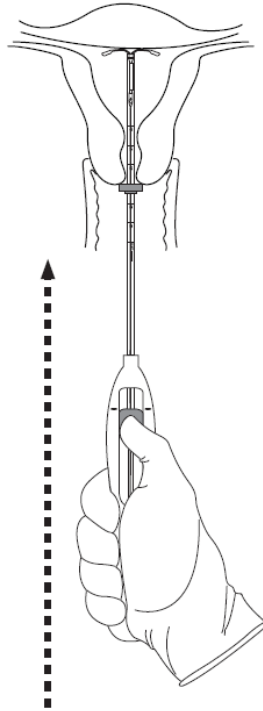

**Figure 5: Move the slider back to the mark to release and open the arms**

Step 6–Advance to fundal position

- Advance the inserter gently towards the fundus of the uterus until the flange touches the cervix. If you encounter fundal resistance do not continue to advance. Mirena is now in the fundal position ([Figure 6](#)). Fundal positioning of Mirena is important to prevent expulsion.





////

**Figure 6: Move Mirena into the fundal position**

Step 7—Release Mirena and withdraw the inserter

- Holding the entire inserter firmly in place, release Mirena by moving the slider all the way down ([Figure 7](#)).

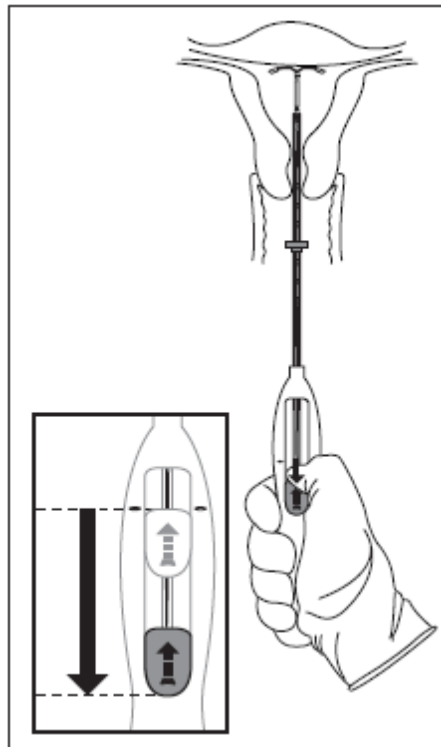

**Figure 7: Move the slider all the way down to release Mirena from the insertion tube**

- Continue to hold the slider all the way down while you slowly and gently withdraw the inserter from the uterus.
- Using a sharp, curved scissor, cut the threads perpendicular, leaving about 3 cm visible outside of the cervix [cutting threads at an angle may leave sharp ends ([Figure 8](#))]. Do not apply tension or pull on the threads when cutting to prevent displacing Mirena.

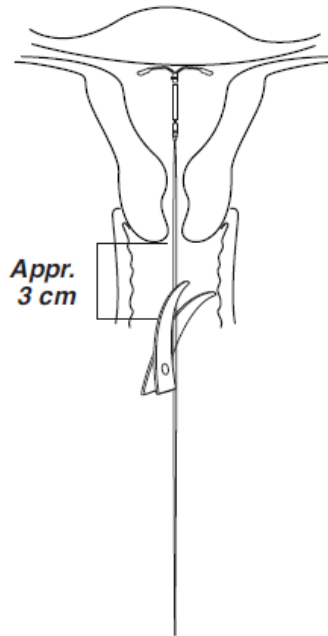

**Figure 8: Cutting the threads**

Mirena insertion is now complete. Prescribe analgesics, if indicated. Record the Mirena lot number in the patient records.

*Important information to consider during or after insertion*

- If you suspect that Mirena is not in the correct position, check placement (for example, using transvaginal ultrasound). Remove Mirena if it is not positioned completely within the uterus. Do not reinsert a removed Mirena.
- If there is clinical concern, exceptional pain or bleeding during or after insertion, take appropriate steps (such as physical examination and ultrasound) immediately to exclude perforation.

**2.3 Patient Follow-up**

- Reexamine and evaluate patients 4 to 6 weeks after insertion and once a year thereafter, or more frequently if clinically indicated.

**2.4 Removal of Mirena**

*Timing of Removal*

- For contraception, remove Mirena by the end of the eighth year and replace at the time of removal with a new Mirena if continued use is desired. Replace Mirena by the end of the fifth year if continued treatment of heavy menstrual bleeding is needed.
- If pregnancy is not desired, remove Mirena during the first 7 days of the menstrual cycle, provided the woman is still experiencing regular menses. If removal will occur at other times during the cycle, or the woman does not experience regular menses, she is at risk of pregnancy; start a new contraceptive method a week prior to removal for these women. [See *Dosage and Administration* ([2.5](#)).]

## Tools for Removal

### Preparation

- Gloves
- Speculum

### Procedure

- Sterile forceps

### *Removal Procedure*

- Remove Mirena by applying gentle traction on the threads with forceps. ([Figure 9](#)).

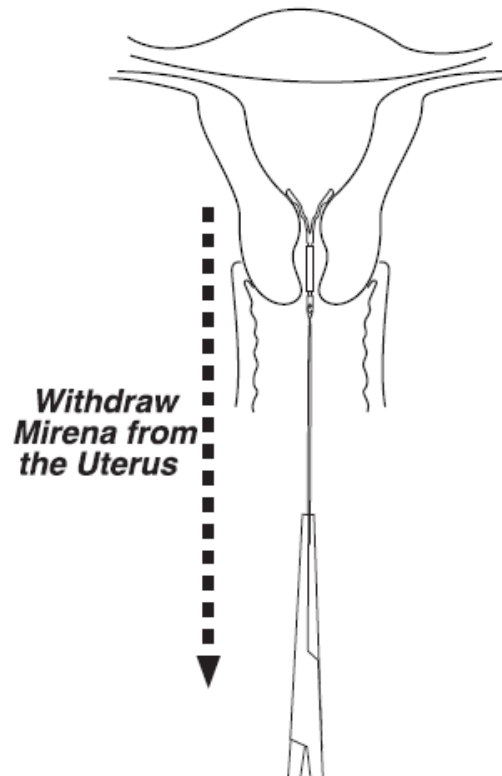

**Figure 9: Removal of Mirena**

- If the threads are not visible, determine location of Mirena by ultrasound [*see Warnings and Precautions (5.10)*].
- If Mirena is found to be in the uterine cavity on ultrasound exam, it may be removed using a narrow forceps, such as an alligator forceps. This may require dilation of the cervical canal. After removal of Mirena, examine the system to ensure that it is intact. The hormone cylinder may slide over and cover the horizontal arms, giving the appearance of missing arms. This situation generally does not require further intervention once the system is verified to be intact.
- If unable to remove with gentle traction, determine Mirena location and exclude perforation by ultrasound or other imaging [*see Warnings and Precautions (5.10)*].
- Removal may be associated with:
  - pain and/or bleeding, vasovagal reactions (for example, syncope, bradycardia) or seizure, especially in patients with a predisposition to these conditions.
  - breakage or embedment of Mirena in the myometrium that can make removal difficult [*see Warnings and Precautions (5.5)*]. Analgesia, paracervical anesthesia, cervical dilation, alligator forceps or other grasping instrument, or hysteroscopy may be used to assist in removal.

## 2.5 Continuation of Contraception after Removal

- If pregnancy is not desired and if a woman wishes to continue using Mirena, a new system can be inserted immediately after removal any time during the cycle.
- If a patient with regular cycles wants to start a different contraceptive method, time removal and initiation of the new method to ensure continuous contraception. Either remove Mirena during the first 7 days of the menstrual cycle and start the new method immediately thereafter or start the new method at least 7 days prior to removing Mirena if removal is to occur at other times during the cycle.
- If a patient with irregular cycles or amenorrhea wants to start a different contraceptive method, start the new method at least 7 days before removal.

## 3 DOSAGE FORMS AND STRENGTHS

Mirena is a LNG-releasing IUS (a type of intrauterine device, or IUD) consisting of a T-shaped polyethylene frame with a steroid reservoir containing a total of 52 mg LNG.

## 4 CONTRAINDICATIONS

The use of Mirena is contraindicated when one or more of the following conditions exist:

- Pregnancy or suspicion of pregnancy [*see Warnings and Precautions (5.2), Use in Specific Populations (8.1)*]
- For use as post-coital contraception (emergency contraception)
- Congenital or acquired uterine anomaly, including fibroids, that distorts the uterine cavity
- Acute pelvic inflammatory disease (PID) or a history of PID unless there has been a subsequent intrauterine pregnancy [*see Warnings and Precautions (5.4)*]
- Postpartum endometritis or infected abortion in the past 3 months
- Known or suspected uterine or cervical malignancy
- Known or suspected breast cancer or other progestin-sensitive cancer, now or in the past
- Uterine bleeding of unknown etiology
- Untreated acute cervicitis or vaginitis, including bacterial vaginosis or other lower genital tract infections until infection is controlled
- Acute liver disease or liver tumor (benign or malignant)
- Conditions associated with increased susceptibility to pelvic infections [*see Warnings and Precautions (5.4)*]
- A previously inserted intrauterine device (IUD) that has not been removed
- Hypersensitivity to any component of this product [*see Adverse Reactions (6.2) and Description (11.1)*]

## 5 WARNINGS AND PRECAUTIONS

### 5.1 Risk of Ectopic Pregnancy

Evaluate women for ectopic pregnancy if they become pregnant with Mirena in place because the likelihood of a pregnancy being ectopic is increased with Mirena. Approximately one-half of pregnancies that occur with Mirena in place are likely to be ectopic. Also consider the possibility of ectopic pregnancy in the case of lower abdominal pain, especially in association with missed menses or if an amenorrheic woman starts bleeding.

The incidence of ectopic pregnancy in clinical trials with Mirena, which excluded women with a history of ectopic pregnancy, was approximately 0.1% per year. The risk of ectopic pregnancy, in women who have a history of ectopic pregnancy and use Mirena is unknown. Women with a previous history of ectopic pregnancy, tubal surgery or pelvic infection carry a higher risk of ectopic pregnancy. Ectopic pregnancy may result in loss of fertility.

## 5.2 Risks with Intrauterine Pregnancy

If pregnancy occurs while using Mirena, remove Mirena because leaving it in place may increase the risk of spontaneous abortion and preterm labor. Removal of Mirena or probing of the uterus may also result in spontaneous abortion. In the event of an intrauterine pregnancy with Mirena, consider the following:

### *Septic abortion*

In patients becoming pregnant with an IUS in place, septic abortion - with septicemia, septic shock, and death - may occur.

### *Continuation of pregnancy*

If a woman becomes pregnant with Mirena in place and if Mirena cannot be removed or the woman chooses not to have it removed, warn her that failure to remove Mirena increases the risk of miscarriage, sepsis, premature labor and premature delivery. Advise her of isolated reports of virilization of the female fetus following local exposure to LNG during pregnancy with an LNG IUS in place [see *Use in Specific Populations (8.1)*]. Follow her pregnancy closely and advise her to report immediately any symptom that suggests complications of the pregnancy.

## 5.3 Sepsis

Severe infection or sepsis, including Group A streptococcal sepsis (GAS), have been reported following insertion of Mirena. In some cases, severe pain occurred within hours of insertion followed by sepsis within days. Because death from GAS is more likely if treatment is delayed, it is important to be aware of these rare but serious infections. Aseptic technique during insertion of Mirena is essential in order to minimize serious infections such as GAS.

## 5.4 Pelvic Infection

Promptly examine users with complaints of lower abdominal or pelvic pain, odorous discharge, unexplained bleeding, fever, genital lesions or sores. Remove Mirena in cases of recurrent endometritis or PID, or if an acute pelvic infection is severe or does not respond to treatment.

### *Pelvic Inflammatory Disease (PID)*

Mirena is contraindicated in the presence of known or suspected PID or in women with a history of PID unless there has been a subsequent intrauterine pregnancy [see *Contraindications (4)*]. IUDs have been associated with an increased risk of PID, most likely due to organisms being introduced into the uterus during insertion. In clinical trials, total combined upper genital infections were reported in 3.5% of Mirena users. More specifically, endometritis was reported in 2.1%, PID in 0.6%, and all other upper genital infections in  $\leq 0.5\%$  of women overall. These infections occurred more frequently within the first year. In a clinical trial with other IUDs<sup>1</sup> and a clinical trial with an IUD similar to Mirena, the highest rate occurred within the first month after insertion.

### Women at increased risk for PID

PID is often associated with a sexually transmitted infection (STI), and Mirena does not protect against STI. The risk of PID is greater for women who have multiple sexual partners, and also for women whose sexual partner(s) have multiple sexual partners. Women who have had PID are at increased risk for a recurrence or re-infection. In particular, ascertain whether the woman is at increased risk of infection (for example, leukemia, acquired immune deficiency syndrome [AIDS], intravenous drug abuse).

### Subclinical PID

PID may be asymptomatic but still result in tubal damage and its sequelae.

### Treatment of PID

Following a diagnosis of PID, or suspected PID, bacteriologic specimens should be obtained, and antibiotic therapy should be initiated promptly. Removal of Mirena after initiation of antibiotic therapy is usually appropriate.<sup>1</sup>

### *Actinomyces*

Actinomyces has been associated with IUDs. Remove Mirena from symptomatic women and treat with antibiotics. The significance of actinomyces-like organisms on Pap smear in an asymptomatic IUD user is unknown, and so this finding

alone does not always require Mirena removal and treatment. When possible, confirm a Pap smear diagnosis with cultures.

### **5.5 Perforation**

Perforation (total or partial, including penetration/embedment of Mirena in the uterine wall or cervix) may occur most often during insertion, although the perforation may not be detected until sometime later. The incidence of perforation during clinical trials, which excluded breast-feeding women, was < 0.1%.

The risk of uterine perforation is increased in women who have recently given birth, and in women who are breastfeeding at the time of insertion. In a large postmarketing safety study conducted in the US, the risk of uterine perforation was highest when insertion occurred within  $\leq 6$  weeks postpartum, and also higher with breastfeeding at the time of insertion [see *Adverse Reactions* (6.2)].

The risk of perforation may be increased if Mirena is inserted when the uterus is fixed, retroverted or not completely involuted.

If perforation occurs, locate and remove Mirena. Surgery may be required. Delayed detection or removal of Mirena in case of perforation may result in migration outside the uterine cavity, adhesions, peritonitis, intestinal perforations, intestinal obstruction, abscesses and erosion of adjacent viscera. In addition, perforation may reduce contraceptive efficacy and result in pregnancy.

### **5.6 Expulsion**

Partial or complete expulsion of Mirena may occur resulting in the loss of efficacy. Expulsion may be associated with symptoms of bleeding or pain, or it may be asymptomatic and go unnoticed. Mirena typically decreases menstrual bleeding over time; therefore, an increase of menstrual bleeding may be indicative of an expulsion. Consider further diagnostic imaging, such as x-ray, if expulsion is suspected based on ultrasound [see *Warnings and Precautions* (5.10)]. In clinical trials, a 4.5% expulsion rate was reported over the 5-year study duration.

The risk of expulsion is increased with insertions immediately after delivery and appears to be increased with insertion after second-trimester abortion based on limited data. In a large postmarketing safety study conducted in the US, the risk of expulsion was lower with breastfeeding status [see *Adverse Reactions* (6.2)].

Remove a partially expelled Mirena. If expulsion has occurred, a new Mirena can be inserted any time the provider can be reasonably certain the woman is not pregnant.

### **5.7 Ovarian Cysts**

Because the contraceptive effect of Mirena is mainly due to its local effects within the uterus, ovulatory cycles with follicular rupture usually occur in women of fertile age using Mirena. Ovarian cysts have been reported in approximately 8% of women using Mirena. Most cysts are asymptomatic, although some may be accompanied by pelvic pain or dyspareunia. In most cases the ovarian cysts disappear spontaneously during two to three months observation. Evaluate persistent ovarian cysts. Surgical intervention is not usually required.

### **5.8 Bleeding Pattern Alterations**

Mirena can alter the bleeding pattern and result in spotting, irregular bleeding, heavy bleeding, oligomenorrhea and amenorrhea. During the first 3–6 months of Mirena use, the number of bleeding and spotting days may be higher and bleeding patterns may be irregular. Thereafter the number of bleeding and spotting days usually decreases but bleeding may remain irregular. If bleeding irregularities develop during prolonged treatment, appropriate diagnostic measures should be taken to rule out endometrial pathology.

Amenorrhea develops in approximately 20% of Mirena users by one year.

If a significant change in bleeding develops during prolonged use, take appropriate diagnostic measures to rule out endometrial pathology. Consider the possibility of pregnancy if menstruation does not occur within six weeks of the onset of previous menstruation. Once pregnancy has been excluded, repeated pregnancy tests are generally not necessary in amenorrheic women unless indicated, for example, by other signs of pregnancy or by pelvic pain [see *Clinical Studies* (14.1)].

In most women with heavy menstrual bleeding, the number of bleeding and spotting days may also increase during the initial months of therapy but usually decrease with continued use; the volume of blood loss per cycle progressively becomes reduced [see *Clinical Studies* (14.2)].

## 5.9 Breast Cancer

Women who currently have or have had breast cancer, or have a suspicion of breast cancer, should not use hormonal contraception, including Mirena, because some breast cancers are hormone-sensitive [see *Contraindications* (4)].

Spontaneous reports of breast cancer have been received during postmarketing experience with Mirena. Observational studies of the risk of breast cancer with use of a LNG-releasing IUS do not provide conclusive evidence of increased risk.

## 5.10 Clinical Considerations for Use and Removal

Use Mirena with caution after careful assessment if any of the following conditions exist, and consider removal of the system if any of them arise during use:

- Coagulopathy or use of anticoagulants
- Migraine, focal migraine with asymmetrical visual loss or other symptoms indicating transient cerebral ischemia
- Exceptionally severe headache
- Marked increase of blood pressure
- Severe arterial disease such as stroke or myocardial infarction

In addition, consider removing Mirena if any of the following conditions arise during use [see *Contraindications* (4)]:

- Uterine or cervical malignancy
- Jaundice

If the threads are not visible or are significantly shortened, they may have broken or retracted into the cervical canal or uterus. Consider the possibility that the system may have been displaced (for example, expelled or perforated the uterus) [see *Warnings and Precautions* (5.5, 5.6)]. Exclude pregnancy and verify the location of Mirena, for example, by sonography, X-ray, or by gentle exploration of the cervical canal with a suitable instrument. If Mirena is displaced, remove it. A new Mirena may be inserted at that time or during the next menses if it is certain that conception has not occurred. If Mirena is in place with no evidence of perforation, no intervention is indicated.

## 6 ADVERSE REACTIONS

The following serious or otherwise important adverse reactions are discussed in elsewhere in the labeling:

- Ectopic Pregnancy [see *Warnings and Precautions* (5.1)]
- Intrauterine Pregnancy [see *Warnings and Precautions* (5.2)]
- Group A Streptococcal Sepsis (GAS) [see *Warnings and Precautions* (5.3)]
- Pelvic Inflammatory Disease [see *Warnings and Precautions* (5.4)]
- Perforation [see *Warnings and Precautions* (5.5)]
- Expulsion [see *Warnings and Precautions* (5.6)]
- Ovarian Cysts [see *Warnings and Precautions* (5.7)]
- Bleeding Pattern Alterations [see *Warnings and Precautions* (5.8)]

### 6.1 Clinical Trials Experience

Because clinical trials are conducted under widely varying conditions, adverse reaction rates observed in the clinical trials of a drug cannot be directly compared to rates in the clinical trials of another drug and may not reflect the rates observed in clinical practice.

The data provided in [Table 2](#) reflect the experience with the use of Mirena in the adequate and well-controlled studies as well as in the supportive and uncontrolled studies for contraception and heavy menstrual bleeding (n=5,091). The data cover more than 12,101 women-years of exposure up to 5 years of use, mainly in the contraception studies (11,761 women-years). The frequencies of reported adverse drug reactions represent crude incidences.

The most common adverse reactions ( $\geq 10\%$  users) are alterations of menstrual bleeding patterns [including unscheduled uterine bleeding (31.9%), decreased uterine bleeding (23.4%), increased scheduled uterine bleeding (11.9%), and female genital tract bleeding (3.5%)], abdominal/pelvic pain (22.6%), amenorrhea (18.4%), headache/migraine (16.3%), genital discharge (14.9%), and vulvovaginitis (10.5%). Adverse reactions reported in  $\geq 5\%$  of users are shown in Table 2.

**Table 2: Adverse Reactions  $\geq 5\%$  Reported in Clinical Trials with Mirena**

System Organ Class	Adverse Reactions	% (N= 5,091)
Reproductive system and breast disorders	alteration of menstrual bleeding pattern, including:	
	unscheduled uterine bleeding	31.9
	decreased uterine bleeding	23.4
	increased scheduled uterine bleeding	11.9
	female genital tract bleeding	3.5
	amenorrhea	18.4
	genital discharge	14.9
	vulvovaginitis	10.5
	breast pain	8.5
	benign ovarian cyst and associated complications	7.5
	dysmenorrhea	6.4
Gastrointestinal disorders	abdominal/pelvic pain	22.6
Nervous system disorders	headache/migraine	16.3
Musculoskeletal and connective tissue disorders	back pain	7.9
Skin and subcutaneous tissue disorders	acne	6.8
Psychiatric disorders	depression/depressive mood	6.4

Other adverse reactions occurring in  $<5\%$  of subjects include alopecia, (partial and complete) device expulsion, hirsutism, nausea, and PID/endometritis.

A separate study with 362 women who have used Mirena for more than 5 years showed a consistent adverse reaction profile in Years 6 through 8 as shown in Table 2. By the end of Year 8 of use, amenorrhea and infrequent bleeding are experienced by 34% and 26% of users, respectively; irregular bleeding occurs in 10%, frequent bleeding in 3%, and prolonged bleeding in 3% of users. In this study, 9% of women reported the adverse event of weight gain; it is unknown if the weight gain was caused by Mirena

## 6.2 Postmarketing Experience

### *Adverse Reactions from Postmarketing Spontaneous Reports*

The following adverse reactions have been identified during post approval use of Mirena. Because these reactions are reported voluntarily from a population of uncertain size, it is not always possible to reliably estimate their frequency or establish a causal relationship to drug exposure.



- Arterial thrombotic and venous thromboembolic events, including cases of pulmonary embolism, deep vein thrombosis and stroke
- Device breakage
- Hypersensitivity (including rash, urticaria and angioedema)
- Increased blood pressure

*Reported Adverse Reactions from Postmarketing Studies*

Assessment of Perforation and Expulsion of Intrauterine Devices (APEX IUD) Study

APEX IUD was a large US retrospective cohort study to assess the impact of breastfeeding and timing of postpartum IUD insertion on uterine perforation and IUD expulsion. The analyses included a total of 326,658 insertions, 30% (97,824 insertions) of which were performed in women with a delivery in the previous 12 months. For insertions performed in women who had delivered  $\leq 52$  weeks before IUD insertion, the majority of postpartum insertions, 57.3% (56,047 insertions) occurred between 6 and 14 weeks postpartum. Breastfeeding data were available in 94,817 insertions performed in women 52 weeks or less after delivery.

The study results indicated that the risk of uterine perforation was highest in women with IUD insertion  $\leq 6$  weeks postpartum. Immediate postpartum insertion (0–3 days) findings are limited due to the relatively small number of insertions occurring within this time interval. Women who were breastfeeding at the time of insertion were at 33% higher risk of perforation (adjusted hazard ratio [HR]=1.33, 95% confidence interval [CI]: 1.07–1.64) compared to women who were not breastfeeding at the time of insertion. Progressively lower risk of uterine perforation was observed in postpartum time windows beyond 6 weeks, in both breastfeeding and not breastfeeding women. Table 3 presents the uterine perforation rates for LNG IUS stratified by breastfeeding status and postpartum interval.

**Table 3: Uterine Perforation<sup>1</sup> rates for LNG IUS, by Breastfeeding Status and Postpartum Interval**

Postpartum interval at time of insertion	Breastfeeding at time of insertion		Not breastfeeding at time of insertion	
	Number of events/ insertions	Uterine perforation rate per 1,000 insertions	Number of events/ insertions	Uterine perforation rate per 1,000 insertions
0 to 3 days	8/1,896	4.22	0/277	0.00
4 days to $\leq 6$ weeks	120/10,735	11.18	28/2,377	11.78
> 6 to $\leq 14$ weeks	268/29,677	9.03	80/12,011	6.66
> 14 to $\leq 52$ weeks	43/6,139	7.00	22/9,089	2.42
> 52 weeks or no delivery	no data available		243/184,733	1.32

<sup>1</sup>Uterine perforation includes both complete and partial perforation

Risk of expulsion was variable over the postpartum intervals through 52 weeks. Women who were breastfeeding were at 28% lower risk of IUD expulsion (adjusted HR=0.72, 95% CI: 0.64-0.80) compared to women who were not breastfeeding at time of insertion. Table 4 presents the IUD expulsion rates for LNG IUS stratified by breastfeeding status and postpartum interval.

**Table 4: Expulsion<sup>1</sup> Rates for LNG IUS, by Breastfeeding Status and Postpartum Interval**

Postpartum interval at time of insertion	Breastfeeding at time of insertion		Not breastfeeding at time of insertion	
	Number of events/ insertions	Expulsion rate per 1,000 insertions	Number of events/ insertions	Expulsion rate per 1,000 insertions
0 to 3 days	187/1,896	98.63	12/277	43.32
4 days to ≤ 6 weeks	185/10,735	17.23	52/2,377	21.88
> 6 to ≤ 14 weeks	421/29,677	14.19	306/12,011	25.48
> 14 to ≤ 52 weeks	120/6,139	19.55	273/9,089	30.04
> 52 weeks or no delivery	no data available		5,481/184,733	29.67

<sup>1</sup>Expulsion includes both complete and partial expulsion

## 7 DRUG INTERACTIONS

No drug-drug interaction studies have been conducted with Mirena.

Drugs or herbal products that induce or inhibit LNG metabolizing enzymes, including CYP3A4, may decrease or increase, respectively, the serum concentrations of LNG during the use of Mirena. However, the contraceptive effect of Mirena is mediated via the direct release of LNG into the uterine cavity and is unlikely to be affected by drug interactions via enzyme induction or inhibition.

## 8 USE IN SPECIFIC POPULATIONS

### 8.1 Pregnancy

#### *Risk Summary*

The use of Mirena is contraindicated in pregnancy or with a suspected pregnancy and Mirena may cause adverse pregnancy outcomes [see *Contraindications (4), Warnings and Precautions (5.1, 5.2)*]. If a woman becomes pregnant with Mirena in place, the likelihood of ectopic pregnancy is increased and there is an increased risk of miscarriage, sepsis, premature labor, and premature delivery. Remove Mirena, if possible, if pregnancy occurs in a woman using Mirena. If Mirena cannot be removed, follow the pregnancy closely [see *Warnings and Precautions (5.1, 5.2)*].

There have been isolated cases of virilization of the external genitalia of the female fetus following local exposure to LNG during pregnancy with an LNG IUS in place.

### 8.2 Lactation

#### *Risk Summary*

Published studies report the presence of LNG in human milk. Small amounts of progestins (approximately 0.1% of the total maternal doses) were detected in the breast milk of nursing mothers who used Mirena, resulting in exposure of LNG to the breastfed infants. There are no reports of adverse effects in breastfed infants with maternal use of progestin-only contraceptives. Isolated cases of decreased milk production have been reported with Mirena. The developmental and health benefits of breastfeeding should be considered along with the mother's clinical need for Mirena and any potential adverse effects on the breastfed child from Mirena or from the underlying maternal condition.

### 8.3 Females and Males of Reproductive Potential

#### *Return to Fertility After Discontinuing Mirena*

In two studies, return to fertility was investigated in a total of 229 women who desired pregnancy after study discontinuation and provided follow-up information. The probability to conceive within 12 months after removal of Mirena was approximately 80%.

## 8.4 Pediatric Use

Safety and efficacy of Mirena have been established in women of reproductive age. Efficacy is expected to be the same for postpubertal females under the age of 18 as for users 18 years and older. Use of this product before menarche is not indicated.

## 8.5 Geriatric Use

Mirena has not been studied in women over age 65 and is not approved for use in this population.

## 11 DESCRIPTION

Mirena (levonorgestrel-releasing intrauterine system) contains 52 mg of LNG, a progestin, and is intended to provide an initial release rate of LNG of approximately 21 mcg/day after 24 days.

Levonorgestrel USP, (-)-13-Ethyl-17-hydroxy-18,19-dinor-17 $\alpha$ -pregn-4-en-20-yn-3-one, the active ingredient in Mirena, has a molecular weight of 312.4, a molecular formula of C<sub>21</sub>H<sub>28</sub>O<sub>2</sub>, and the following structural formula:

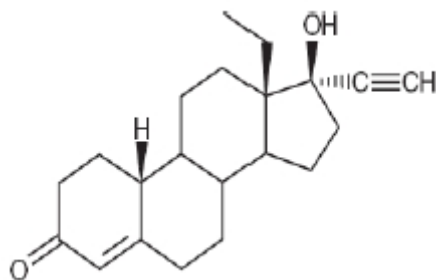

### 11.1 Mirena

Mirena consists of a T-shaped polyethylene frame (T-body) with a steroid reservoir (hormone elastomer core) around the vertical stem. The white T-body has a loop at one end of the vertical stem and two horizontal arms at the other end. The reservoir consists of a white or almost white cylinder, made of a mixture of LNG and silicone (polydimethylsiloxane), containing a total of 52 mg LNG. The reservoir is covered by a semi-opaque silicone membrane, composed of polydimethylsiloxane and colloidal silica. The T-body is 32 mm in both the horizontal and vertical directions. The polyethylene of the T-body is compounded with barium sulfate, which makes it radiopaque. A monofilament brown polyethylene removal thread is attached to a loop at the end of the vertical stem of the T-body. The polyethylene of the removal thread contains iron oxide as a colorant (see [Figure 10](#)).

The components of Mirena, including its packaging, are not manufactured using natural rubber latex.

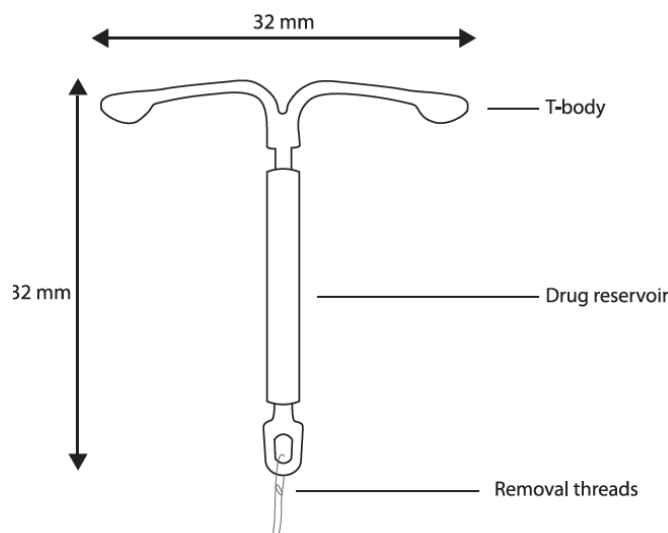

**Figure 10: Mirena**

## 11.2 Inserter

Mirena is packaged sterile within an inserter. The inserter (Figure 11), which is used for insertion of Mirena into the uterine cavity, consists of a symmetric two-sided body and slider that are integrated with flange, lock, pre-bent insertion tube and plunger. The outer diameter of the insertion tube is 4.4 mm. The vertical stem of Mirena is loaded in the insertion tube at the tip of the inserter. The arms are pre-aligned in the horizontal position. The removal threads are contained within the insertion tube and handle. Once Mirena has been placed, the inserter is discarded.

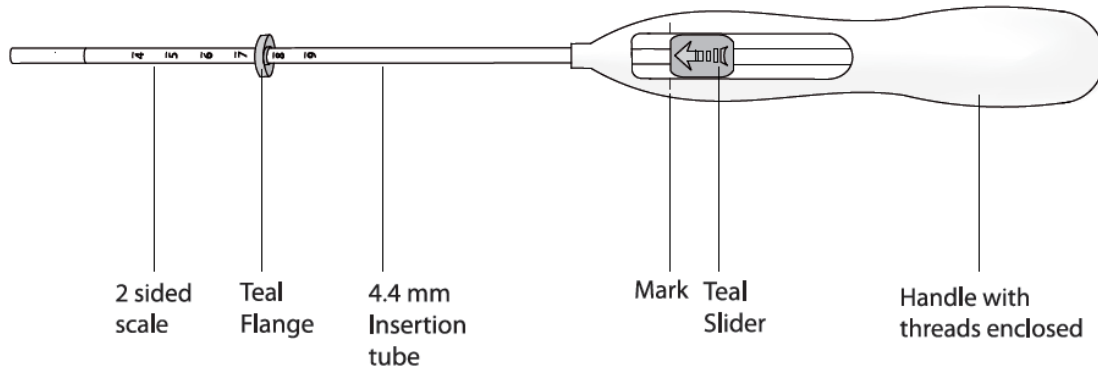

**Figure 11: Diagram of Inserter**

## 12 CLINICAL PHARMACOLOGY

### 12.1 Mechanism of Action

The local mechanism by which continuously released LNG contributes to the contraceptive effectiveness of Mirena has not been conclusively demonstrated. Studies of Mirena and similar LNG IUS prototypes have suggested several mechanisms that prevent pregnancy: thickening of cervical mucus preventing passage of sperm into the uterus, inhibition of sperm capacitation or survival, and alteration of the endometrium.

### 12.2 Pharmacodynamics

Mirena has mainly local progestogenic effects in the uterine cavity. The local concentrations of LNG lead to morphological changes including stromal pseudodecidualization, glandular atrophy, a leukocytic infiltration and a decrease in glandular and stromal mitoses.

Ovulation is inhibited in some women using Mirena. In a 1-year study, approximately 45% of menstrual cycles were ovulatory, and in another study after 4 years, 75% of cycles were ovulatory.

### 12.3 Pharmacokinetics

#### *Absorption*

Low doses of LNG are administered into the uterine cavity with the Mirena intrauterine delivery system.

Estimated in vivo release rates for different points in time are provided in Table 5.

**Table 5: Estimated in vivo release rates for Mirena**

Time	Estimated in vivo release rate [µg/day] (rounded)
24 days after insertion	21
60 days after insertion	21
1 year after insertion	19
3 years after insertion	14
5 years after insertion	11
6 years after insertion	9
7 years after insertion	8
8 years after insertion	7
Average over 1st year	20
Average over 3 years	18
Average over 5 years	15
Average over 8 years	13

After insertion of Mirena, LNG is detectable in serum/plasma after 1 hour. The maximum concentration is reached within 2 weeks after insertion and amounts to about 180 ng/L (CV 38%). In correspondence with the declining release rate, the geometric mean serum/plasma concentration of levonorgestrel declines continuously:

**Table 6: Estimated Total LNG Mean Plasma Concentrations**

Time after insertion	Total LNG plasma concentrations [ng/L] (geometric CV%)
24 days	175 (37.6)
2 months	169 (37.1)
1 year	159 (37.4)
3 years	139 (37.8)
5 years	123 (38.2)
8 years	100 (39.9)

### *Distribution*

LNG is bound non-specifically to serum albumin and specifically to the Sex hormone-binding globulin (SHBG.) Less than 2% of the circulating LNG is present as free steroid. Levonorgestrel binds with high affinity to SHBG. Accordingly, changes in the concentration of SHBG in serum result in an increase (at higher SHBG concentrations) or in a decrease (at lower SHBG concentrations) of the total levonorgestrel concentration in serum. The concentration of SHBG declined on average by about 20% during the two months after insertion of Mirena and remained stable during thereafter, increasing only slightly until the end of the 8 years of use.

The apparent volume of distribution of LNG is reported to be approximately 1.8 L/kg.

### *Elimination*

Following intravenous administration of 0.09 mg LNG to healthy volunteers, the total clearance of LNG is approximately 1 mL/min/kg and the elimination half-life is approximately 20 hours. Metabolic clearance rates may differ among

individuals by several-fold, and this may account in part for wide individual variations in LNG concentrations seen in individuals using LNG-containing contraceptive products.

### Metabolism

Following absorption, LNG is extensively metabolized. The most important metabolic pathways are the reduction of the  $\Delta 4$ -3-oxo group and hydroxylations at positions 2 $\alpha$ , 1 $\beta$  and 16 $\beta$ , followed by conjugation. Significant amounts of conjugated and unconjugated 3 $\alpha$ , 5 $\beta$ -tetra-hydrolevonorgestrel are also present in serum, along with much smaller amounts of 3 $\alpha$ , 5 $\alpha$ -tetrahydrolevonorgestrel and 16 $\beta$ -hydroxylevonorgestrel. CYP3A4 is the main enzyme involved in the oxidative metabolism of LNG.

### Excretion

LNG and its phase I metabolites are excreted primarily as glucuronide conjugates. About 45% of LNG and its metabolites are excreted in the urine and about 32% are excreted in feces, mostly as glucuronide conjugates.

### *Specific Populations*

**Pediatric:** Safety and efficacy of Mirena have been established in women of reproductive age. Use of this product before menarche is not indicated.

**Geriatric:** Mirena has not been studied in women over age 65 and is not currently approved for use in this population.

**Race:** No studies have evaluated the effect of race on the pharmacokinetics of Mirena.

**Hepatic Impairment:** No studies were conducted to evaluate the effect of hepatic disease on the disposition of Mirena.

**Renal Impairment:** No formal studies were conducted to evaluate the effect of renal disease on the disposition of Mirena.

### *Drug-Drug Interactions*

No drug-drug interaction studies were conducted with Mirena [see *Drug Interactions* (7)].

## **13 NONCLINICAL TOXICOLOGY**

### **13.1 Carcinogenesis, Mutagenesis, Impairment of Fertility**

[See *Warnings and Precautions* (5.9)]

## **14 CLINICAL STUDIES**

### **14.1 Clinical Trials on Contraception**

The safety and effectiveness of Mirena was studied in two clinical trials in Finland and Sweden. In these trials, 1,169 women 18 to 35 years of age at enrollment used Mirena for up to 5 years, for a total of 45,000 women-months of exposure. Of these, 5.6% (66) were nulliparous women. Subjects had previously been pregnant, had no history of ectopic pregnancy, had no history of pelvic inflammatory disease over the preceding 12 months, were predominantly White, and over 70% of the subjects had previously used IUDs (intrauterine devices). The reported 12-month pregnancy rates were less than or equal to 0.2 per 100 women (0.2%) and the cumulative 5-year pregnancy rate was approximately 0.7 per 100 women (0.7%).

The contraceptive efficacy of Mirena during extended use beyond 5 years was studied in the Mirena Extension Trial (NCT02985541), a multi-center, open-label, uncontrolled study conducted in the United States. The trial enrolled women 18 to 35 years of age who had been using Mirena for not less than 4.5 years and not more than 5 years at enrollment. The population consisted of 362 women using Mirena. Of these 47.2% were nulliparous. The women were predominantly White (75.4%); 14.1% of the women were Black/African American, and 2.5% were Asian; 11.3 % were Hispanic. The weight range was 38.5–163.5 kg (mean weight: 75.6 kg) and mean BMI was 27.9 kg/m<sup>2</sup> (range: 15.4–57.7 kg/m<sup>2</sup>).

The pregnancy rate calculated as the Pearl Index (PI) was the primary efficacy endpoint used to assess contraceptive efficacy. The PI was based on 28-day equivalent exposure cycles; evaluable cycles excluded those in which back-up contraception was used unless a pregnancy occurred in that cycle. The PI for the 6th year of use based on the 1 pregnancy that occurred during Year 6 and within 7 days after Mirena removal or expulsion and 3,870 evaluable cycles was 0.34 with a 95% upper confidence limit of 1.88 and the PI for the 7th year of use based on the 1 pregnancy that occurred during

Year 7 and within 7 days after Mirena removal or expulsion and 3,232 evaluable cycles was 0.40 with a 95% upper confidence limit of 2.25. The PI for the 8th year of use based on no pregnancies occurring during Year 8 and within 7 days after Mirena removal or expulsion and 2,534 evaluable cycles was 0.00 with a 95% upper confidence limit of 1.90.

The cumulative 3-year pregnancy rate for Years 6, 7 and 8 was estimated by the Kaplan-Meier method. Based on 2 pregnancies (1 in Year 6 and 1 in Year 7) and 10,216 exposure cycles, the cumulative pregnancy rate at the end of the 3-year period of extended use (Years 6, 7 and 8) was 0.68% with a 95% upper confidence limit of 2.71%.

## 14.2 Clinical Trial on Heavy Menstrual Bleeding

The efficacy of Mirena in the treatment of heavy menstrual bleeding was studied in a randomized, open-label, active-control, parallel-group trial comparing Mirena (n=79) to an approved therapy, medroxyprogesterone acetate (MPA) (n=81), over 6 cycles. The subjects included reproductive-aged women in good health, with no contraindications to the drug products and with confirmed heavy menstrual bleeding ( $\geq 80$  mL menstrual blood loss [MBL]) determined using the alkaline hematin method. Excluded were women with organic or systemic conditions that may cause heavy uterine bleeding (except small fibroids, with total volume not  $> 5$  mL). Treatment with Mirena showed a statistically significantly greater reduction in MBL (see [Figure 12](#)) and a statistically significantly greater number of subjects with successful treatment (see [Figure 13](#)). Successful treatment was defined as proportion of subjects with (1) end-of-study MBL  $< 80$  mL and (2) a  $\geq 50\%$  decrease in MBL from baseline to end-of-study.

**Figure 12: Median Menstrual Blood Loss (MBL) by Time and Treatment**

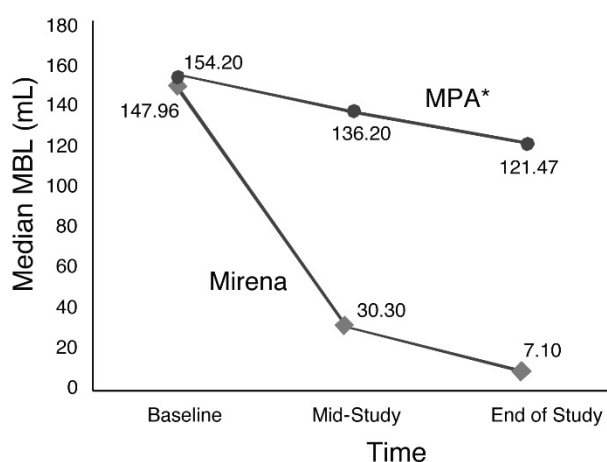

\*MPA=medroxyprogesterone acetate

**Figure 13: Proportion of Subjects with Successful Treatment**

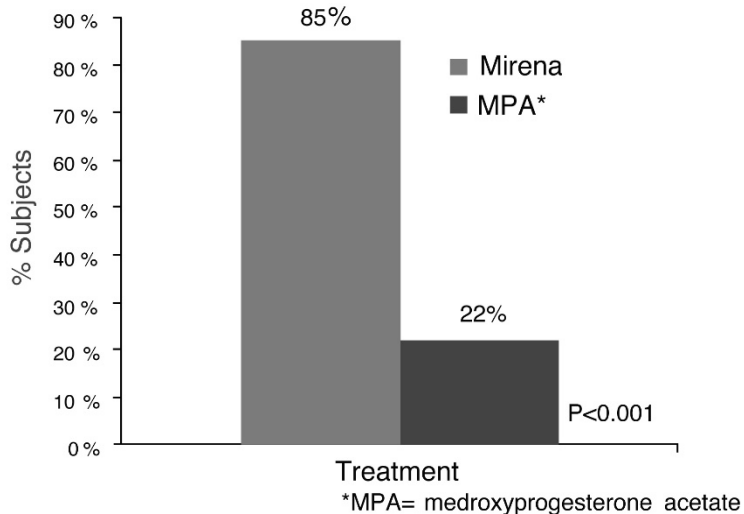

## 15 REFERENCES

<sup>1</sup> <http://www.cdc.gov/std/tg2015/pid.htm>. Accessed August 22, 2016.

## 16 HOW SUPPLIED/STORAGE AND HANDLING

Mirena (levonorgestrel-releasing intrauterine system), containing a total of 52 mg LNG, is available in a carton of one sterile unit NDC# 50419-423-01.

Mirena is supplied sterile. Mirena is sterilized with ethylene oxide. Do not resterilize. For single use only. Do not use if the inner package is damaged or open. Insert before the end of the month shown on the label.

Store at 25°C (77°F); with excursions permitted between 15–30°C (59–86°F) [see USP Controlled Room Temperature].

## 17 PATIENT COUNSELING INFORMATION

Advise the patient to read the FDA-approved patient labeling (Patient Information)

- **Sexually Transmitted Infections:** Advise the patient that this product does not protect against HIV infection (AIDS) and other sexually transmitted infections (STIs).
- **Risk of Ectopic Pregnancy:** Advise the patient about the risks of ectopic pregnancy, including the loss of fertility. Teach her to recognize and report to her healthcare provider promptly any symptoms of ectopic pregnancy. [*See Warnings and Precautions (5.1).*]
- **Risks of Intrauterine Pregnancy:** Advise the patient to contact her healthcare provider if she thinks she might be pregnant. Inform the patient about the risks of intrauterine pregnancy while using Mirena, including the risks of leaving Mirena in place and the risks of removing Mirena or probing of the uterus. If Mirena cannot be removed in a pregnant patient, advise her to report immediately any symptom that suggests complications of the pregnancy. Advise her of isolated reports of virilization of the female fetus following local exposure to LNG during pregnancy with an LNG IUS in place. [*See Warnings and Precautions (5.2) and Use in Special Populations (8.1).*]
- **Sepsis:** Counsel the patient that severe infection or sepsis, including Group A streptococcal sepsis (GAS), can occur within the first few days after Mirena is inserted. Instruct her to contact a healthcare provider immediately if she develops severe pain or fever shortly after Mirena is inserted. [*See Warnings and Precautions (5.3).*]
- **Pelvic Infection:** Advise the patient about the possibility of pelvic infections, including PID, and that these infections can cause tubal damage leading to ectopic pregnancy or infertility, or infrequently can necessitate hysterectomy, or cause death. Teach patients to recognize and report to their healthcare provider promptly any symptoms of pelvic infection. These symptoms include development of menstrual disorders (prolonged or heavy bleeding), unusual vaginal discharge, abdominal or pelvic pain or tenderness, dyspareunia, chills, and fever. [*See Warnings and Precautions (5.4).*]
- **Perforation and Expulsion:** Advise the patient that the IUS may be expelled from or perforate the uterus and instruct her on how she can check that the threads still protrude from the cervix. Inform her that excessive pain or vaginal bleeding during Mirena placement, worsening pain or bleeding after placement, or the inability to feel Mirena strings may occur with Mirena perforation and expulsion. Caution her not to pull on the threads and displace Mirena. Inform her that there is no contraceptive protection if Mirena is displaced or expelled. Instruct the patient to contact her healthcare provider if she cannot feel the threads and to avoid intercourse or use a non-hormonal back-up birth control (such as condoms or spermicide) until the location of Mirena has been confirmed. Advise her that if perforation occurs, Mirena will have to be located and removed; surgery may be required. [*See Warnings and Precautions (5.5, 5.6, 5.10).*]
- **Ovarian Cysts:** Advise the patient regarding the risk of ovarian cysts and that cysts can cause clinical symptoms including pelvic pain, abdominal pain or dyspareunia. Advise the patient to contact her healthcare provider if she experiences these symptoms. [*See Warnings and Precautions (5.7).*]
- **Bleeding Pattern Alterations:** Advise the patient that irregular or prolonged bleeding and spotting, and/or cramps may occur during the first few weeks after insertion. Inform the patient that, during the first 3–6 months of Mirena use, the number of bleeding and spotting days may be higher and bleeding patterns may be irregular. If her symptoms continue or are severe, she should report them to her healthcare provider. [*See Warnings and Precautions (5.8).*]
- **Clinical Considerations for Use and Removal:** Advise the patient to contact her healthcare provider if she experiences any of the following:
  - A stroke or heart attack
  - Very severe or migraine headaches
  - Unexplained fever
  - Yellowing of the skin or whites of the eyes, as these may be signs of serious liver problems
  - Pregnancy or suspected pregnancy
  - Pelvic pain, abdominal pain, or pain during sex
  - HIV positive seroconversion in herself or her partner
  - Possible exposure to STIs



- Unusual vaginal discharge or genital sores
- Severe vaginal bleeding or bleeding that lasts a long time, or if she misses a menstrual period
- Inability to feel Mirena's threads

Manufactured for:

Bayer HealthCare Pharmaceuticals Inc.  
Whippany, NJ 07981

© 2000, Bayer HealthCare Pharmaceuticals Inc.  
All rights reserved.

**Patient Information**  
**MIRENA® (mur-ā-nah)**  
(levonorgestrel-releasing intrauterine system)

Read this Patient Information carefully before you decide if MIRENA is right for you. This information does not take the place of talking with your gynecologist or other healthcare provider who specializes in women's health. If you have any questions about MIRENA, ask your healthcare provider. You should also learn about other birth control methods to choose the one that is best for you.

**MIRENA does not protect against HIV infection (AIDS) and other sexually transmitted infections (STIs).**

**What is MIRENA?**

- MIRENA is a hormone-releasing system placed in your uterus by your healthcare provider to prevent pregnancy for up to 8 years.
- MIRENA can also be used to decrease menstrual blood loss for up to 5 years in women who have heavy menstrual flow and who also want to use a birth control method that is placed in the uterus to prevent pregnancy.
- MIRENA can be removed by your healthcare provider at any time.
- MIRENA can be used whether or not you have given birth to a child.

MIRENA is a small flexible plastic T-shaped system that slowly releases a progestin hormone called levonorgestrel (LNG) that is often used in birth control pills. Because MIRENA releases LNG into your uterus, only small amounts of the hormone enter your blood. MIRENA does not contain estrogen.

Two thin threads are attached to the stem (lower end) of MIRENA. The threads are the only part of MIRENA you can feel when MIRENA is in your uterus; however, unlike a tampon string, the threads do not extend outside your body.

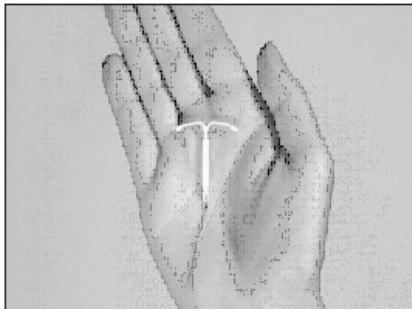

MIRENA is small

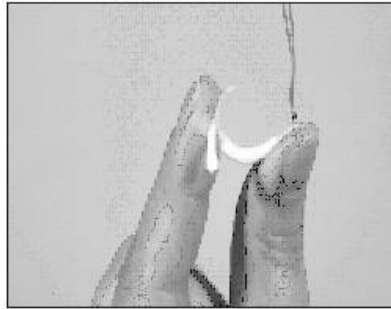

and flexible

**What if I need birth control for more than 8 years?**

MIRENA must be removed after 8 years. Your healthcare provider can place a new MIRENA during the same office visit if you choose to continue using MIRENA.

**What if I need treatment for heavy menstrual flow for more than 5 years?**

For continued treatment of heavy menstrual flow after 5 years, your healthcare provider can remove MIRENA and place a new MIRENA during the same office visit.

### **What if I want to stop using MIRENA?**

MIRENA is intended for use up to 8 years, but you can stop using MIRENA at any time by asking your healthcare provider to remove it. You could become pregnant as soon as MIRENA is removed, so you should use another method of birth control if you do not want to become pregnant. Talk to your healthcare provider about the best birth control methods for you, because your new method may need to be started 7 days before MIRENA is removed to prevent pregnancy.

### **What if I change my mind about birth control and want to become pregnant in less than 8 years?**

Your healthcare provider can remove MIRENA at any time. You may become pregnant as soon as MIRENA is removed. About 8 out of 10 women who want to become pregnant will become pregnant sometime in the first year after MIRENA is removed.

### **How does MIRENA work?**

MIRENA may work in several ways including thickening cervical mucus, inhibiting sperm movement, reducing sperm survival, and thinning the lining of your uterus. It is not known exactly how these actions work together to prevent pregnancy.

MIRENA can cause your menstrual bleeding to be less by thinning the lining of the uterus.

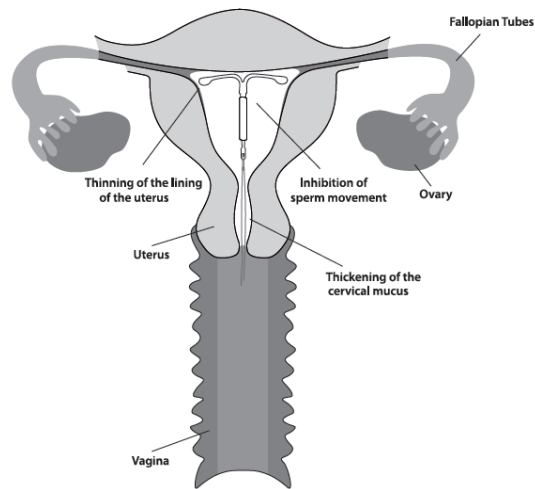

## How well does MIRENA work for contraception?

The following chart shows the chance of getting pregnant for women who use different methods of birth control. Each box on the chart contains a list of birth control methods that are similar in effectiveness. The most effective methods are at the top of the chart. The box on the bottom of the chart shows the chance of getting pregnant for women who do not use birth control and are trying to get pregnant.

MIRENA, an intrauterine device (IUD), also known as an intrauterine system (IUS), is in the box at the top of the chart.

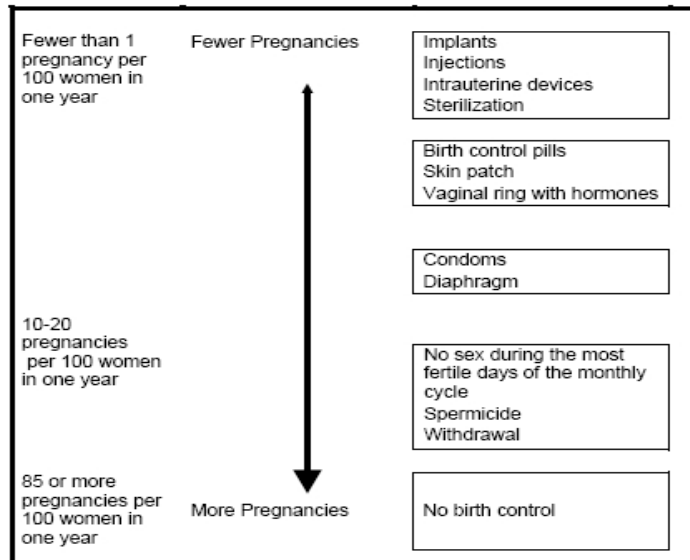

## How well does MIRENA work for heavy menstrual bleeding?

In the clinical trial performed in women with heavy menstrual bleeding and treated with MIRENA, almost 9 out of 10 were treated successfully and their blood loss was reduced by more than half.

## Who might use MIRENA?

You might choose MIRENA if you:

- want long-term birth control that provides a low chance of getting pregnant (less than 1 in 100)
- want birth control that works continuously for up to 8 years
- want birth control that is reversible
- want a birth control method that you do not need to take daily
- want treatment for heavy periods up to 5 years and are willing to use a birth control method that is placed in the uterus
- want birth control that does not contain estrogen

**Do not use MIRENA if you:**

- are or might be pregnant; MIRENA cannot be used as an emergency contraceptive
- have a serious pelvic infection called pelvic inflammatory disease (PID) or have had PID in the past unless you have had a normal pregnancy after the infection went away
- have an untreated genital infection now
- have had a serious pelvic infection in the past 3 months after a pregnancy
- can get infections easily. For example, if you:
  - have multiple sexual partners or your partner has multiple sexual partners
  - have problems with your immune system
  - use or abuse intravenous drugs
- have or suspect you might have cancer of the uterus or cervix
- have bleeding from the vagina that has not been explained
- have liver disease or a liver tumor
- have breast cancer or any other cancer that is sensitive to progestin (a female hormone), now or in the past
- have an intrauterine device in your uterus already
- have a condition of the uterus that changes the shape of the uterine cavity, such as large fibroid tumors
- are allergic to levonorgestrel, silicone, polyethylene, silica, barium sulfate or iron oxide

**Before having MIRENA placed, tell your healthcare provider about all of your medical conditions including if you:**

- have any of the conditions listed above
- have had a heart attack
- have had a stroke
- were born with heart disease or have problems with your heart valves
- have problems with blood clotting or take medicine to reduce clotting
- have high blood pressure
- recently had a baby or are breastfeeding
- have severe headaches or migraine headaches
- have AIDS, HIV, or any other sexually transmitted infection

Tell your healthcare provider about all of the medicines you take, including prescription and over-the-counter medicines, vitamins, and herbal supplements.

**How is MIRENA placed?**

MIRENA is placed by your healthcare provider during an in-office visit or immediately after giving birth.

First, your healthcare provider will examine your pelvis to find the exact position of your uterus. Your healthcare provider will then clean your vagina and cervix with an antiseptic solution and slide a slim plastic tube containing MIRENA through the cervix into your uterus. Your healthcare provider will then remove the plastic tube and leave MIRENA in your uterus. Your healthcare provider will cut the threads to the right length.

You may experience pain, bleeding or dizziness during and after placement. If your symptoms do not pass within 30 minutes after placement, MIRENA may not have been placed correctly. Your healthcare provider will examine you to see if MIRENA needs to be removed or replaced.

**Should I check that MIRENA is in place?**

Yes, you should check that MIRENA is in proper position by feeling the removal threads. It is a good habit to do this 1 time a month. Your healthcare provider should teach you how to check that MIRENA is in place. First, wash your hands with soap and water. You can check by reaching up to the top of your vagina with clean fingers to feel the removal threads. Do not pull on the threads.

If you feel more than just the threads or if you cannot feel the threads, MIRENA may not be in the right position and may not prevent pregnancy. Avoid intercourse or use non-hormonal back-up birth control (such as condoms or spermicide) and ask your healthcare provider to check that MIRENA is still in the right place.

#### **How soon after placement of MIRENA should I return to my healthcare provider?**

Call your healthcare provider if you have any questions or concerns (see "When should I call my healthcare provider?"). Otherwise, you should return to your healthcare provider for a follow-up visit 4 to 6 weeks after MIRENA is placed to make sure that MIRENA is in the right position.

#### **Can I use tampons or menstrual cups with MIRENA?**

Yes, tampons or menstrual cups may be used with MIRENA. Change tampons or menstrual cups with care to avoid pulling the threads of Mirena. If you think you may have pulled Mirena out of place, avoid intercourse or use a non-hormonal back-up birth control (such as condoms or spermicide), and contact your healthcare provider.

#### **What if I become pregnant while using MIRENA?**

Call your healthcare provider right away if you think you may be pregnant. If possible, also do a urine pregnancy test. If you get pregnant while using MIRENA, you may have an ectopic pregnancy. This means that the pregnancy is not in the uterus. Unusual vaginal bleeding or abdominal pain especially with missed periods may be a sign of ectopic pregnancy.

Ectopic pregnancy is a medical emergency that often requires surgery. Ectopic pregnancy can cause internal bleeding, infertility, and even death.

There are also risks if you get pregnant while using MIRENA and the pregnancy is in the uterus. Severe infection, miscarriage, premature delivery, and even death can occur with pregnancies that continue with an intrauterine device (IUD). Because of this, your healthcare provider may try to remove MIRENA, even though removing it may cause a miscarriage. If MIRENA cannot be removed, talk with your healthcare provider about the benefits and risks of continuing the pregnancy and possible effects of the hormone on your unborn baby.

If you continue your pregnancy, see your healthcare provider regularly. Call your healthcare provider right away if you get flu-like symptoms, fever, chills, cramping, pain, bleeding, vaginal discharge, or fluid leaking from your vagina. These may be signs of infection.

#### **How will MIRENA change my periods?**

For the first 3 to 6 months, your period may become irregular and the number of bleeding days may increase. You may also have frequent spotting or light bleeding, and some women have heavy bleeding during this time. You may also have cramping during the first few weeks. After you have used MIRENA for a while, the number of bleeding and spotting days is likely to lessen. For some women, periods will stop altogether. When Mirena is removed, your menstrual periods should return.

In some women with heavy bleeding, the total blood loss per cycle progressively decreases with continued use. The number of spotting and bleeding days may initially increase but then typically decreases in the months that follow.

#### **Is it safe to breastfeed while using MIRENA?**

You may use MIRENA when you are breastfeeding. MIRENA is not likely to affect the quality or amount of your breast milk or the health of your nursing baby. However, isolated cases of decreased milk production have been reported. The risk of MIRENA going into the wall of the uterus (becoming embedded) or going through the wall of the uterus is increased if MIRENA is inserted while you are breastfeeding.

### Will MIRENA interfere with sexual intercourse?

You and your partner should not feel MIRENA during intercourse. MIRENA is placed in the uterus, not in the vagina. Sometimes your partner may feel the threads. If this occurs, or if you or your partner experience pain during sex, talk with your healthcare provider.

### What are the possible side effects of MIRENA?

#### MIRENA can cause serious side effects including:

- **Ectopic pregnancy and intrauterine pregnancy risks.** There are risks if you become pregnant while using Mirena (see "What if I become pregnant while using Mirena?").
- **Life-threatening infection.** Life-threatening infection can occur within the first few days after MIRENA is placed. Call your healthcare provider immediately if you develop severe pain or fever shortly after MIRENA is placed.
- **Pelvic inflammatory disease (PID).** Some IUD users get a serious pelvic infection called pelvic inflammatory disease. PID is usually sexually transmitted. You have a higher chance of getting PID if you or your partner has sex with other partners. PID can cause serious problems such as infertility, ectopic pregnancy or pelvic pain that does not go away. PID is usually treated with antibiotics. More serious cases of PID may require surgery including removal of the uterus (hysterectomy). In rare cases, infections that start as PID can even cause death.

Tell your healthcare provider right away if you have any of these signs of PID: long-lasting or heavy bleeding, unusual vaginal discharge, low abdominal (stomach area) pain, painful sex, chills, fever, genital lesions or sores.

- **Perforation.** MIRENA may go into the wall of the uterus (become embedded) or go through the wall of the uterus. This is called perforation. If this occurs, MIRENA may no longer prevent pregnancy. If perforation occurs, MIRENA may move outside the uterus and can cause internal scarring, infection, or damage to other organs, and you may need surgery to have MIRENA removed. Excessive pain or vaginal bleeding during placement of MIRENA, pain or bleeding that gets worse after placement, or not being able to feel the threads may happen with perforation. The risk of perforation is increased if MIRENA is inserted while you are breastfeeding, or if you have recently given birth.
- **Expulsion.** MIRENA may come out by itself. This is called expulsion. Excessive pain or vaginal bleeding during placement of MIRENA, pain or bleeding that gets worse after placement, or not being able to feel the threads may happen with expulsion. You may become pregnant if MIRENA comes out. If you think that MIRENA has come out, avoid intercourse or use a non-hormonal back-up birth control (such as condoms or spermicide) and call your healthcare provider. The risk of expulsion is increased with insertion right after delivery or second-trimester abortion.

#### Common side effects of Mirena include:

- **Pain, bleeding or dizziness during and after placement.** If these symptoms do not stop 30 minutes after placement, MIRENA may not have been placed correctly. Your healthcare provider will examine you to see if MIRENA needs to be removed or replaced.
- **Changes in bleeding.** You may have bleeding and spotting between menstrual periods, especially during the first 3 to 6 months. Sometimes the bleeding is heavier than usual at first. However, the bleeding usually becomes lighter than usual and may be irregular. Call your healthcare provider if the bleeding remains heavier than usual or increases after it has been light for a while.
- **Missed menstrual periods.** About 2 out of 10 women stop having periods after 1 year of MIRENA use. If you have any concerns that you may be pregnant while using MIRENA, do a urine pregnancy test and call your healthcare provider. If you do not have a period for 6 weeks during MIRENA use, call your healthcare provider. When MIRENA is removed, your menstrual periods should return.
- **Cysts on the ovary.** Some women using MIRENA develop a painful cyst on the ovary. These cysts usually disappear on their own in 2 to 3 months. However, cysts can cause pain and sometimes cysts will need surgery.

Other common side effects include:

- abdominal or pelvic pain
- inflammation or infection of the outer part of your vagina (vulvovaginitis)
- headache or migraine
- vaginal discharge

These are not all of the possible side effects with MIRENA. For more information, ask your healthcare provider.

**Call your doctor for medical advice about side effects.** You may report side effects to FDA at 1-800-FDA-1088. You may also report side effects to Bayer Healthcare Pharmaceuticals at 1-888-842-2937.

#### **After MIRENA has been placed, when should I call my healthcare provider?**

If Mirena is accidentally removed and you had vaginal intercourse within the preceding week, you may be at risk of pregnancy, and you should talk to a healthcare provider.

Call your healthcare provider if you have any concerns about MIRENA. Be sure to call if you:

- think you are pregnant
- have pelvic pain, abdominal pain or pain during sex
- have unusual vaginal discharge or genital sores
- have unexplained fever, flu-like symptoms or chills
- might be exposed to sexually transmitted infections (STIs)
- are concerned that Mirena may have been expelled (came out)
- cannot feel MIRENA's threads
- develop very severe or migraine headaches
- have yellowing of the skin or whites of the eyes. These may be signs of liver problems.
- have had a stroke or heart attack
- become HIV positive or your partner becomes HIV positive
- have severe vaginal bleeding or bleeding that lasts a long time or concerns you

#### **General advice about the safe and effective use of MIRENA.**

Medicines are sometimes prescribed for purposes other than those listed in patient information leaflets. If you would like more information, talk with your healthcare provider. You can ask your healthcare provider for information about MIRENA that is written for health professionals.

#### **What are the ingredients in MIRENA?**

**Active ingredient:** levonorgestrel

**Inactive ingredients:** silicone, polyethylene, silica, barium sulfate, iron oxide

Manufactured for:

Bayer HealthCare Pharmaceuticals Inc.  
Whippany, NJ 07981

© 2000, Bayer HealthCare Pharmaceuticals Inc.  
All rights reserved.

For more information, go to [www.MIRENA-us.com](http://www.MIRENA-us.com) or call 1-888-842-2937